

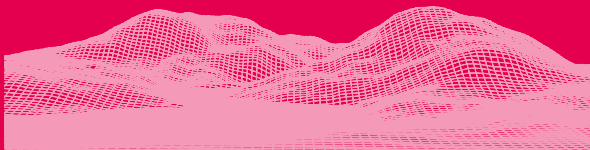

SONIC 4K
2 0 2 2



Dear User,

Thank you for joining us. Please read through the entire manual and follow step-by-step instructions to get the best printing experience.

If you have any technical questions, please contact us [✉ support@phrozen3d.com](mailto:support@phrozen3d.com)

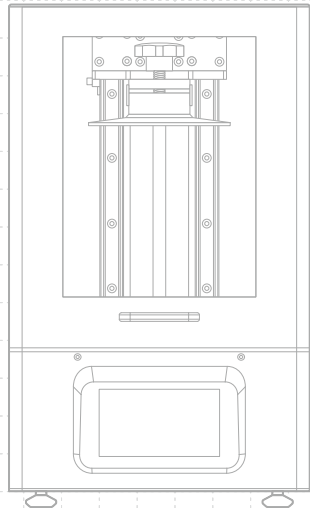

01 Introduction

Printer Parts

PART.1
Building Plate

PART.2
Air Filtration System

PART.3
Resin Vat

PART.4
LCD

PART.5
Touch Panel

PART.8
Power Switch
Power Socket

PART.9
Network Port

PART.10
USB Port

PART.11
Phrozen OS
SD Card

PART.6
Heater

PART.7
Z-axis

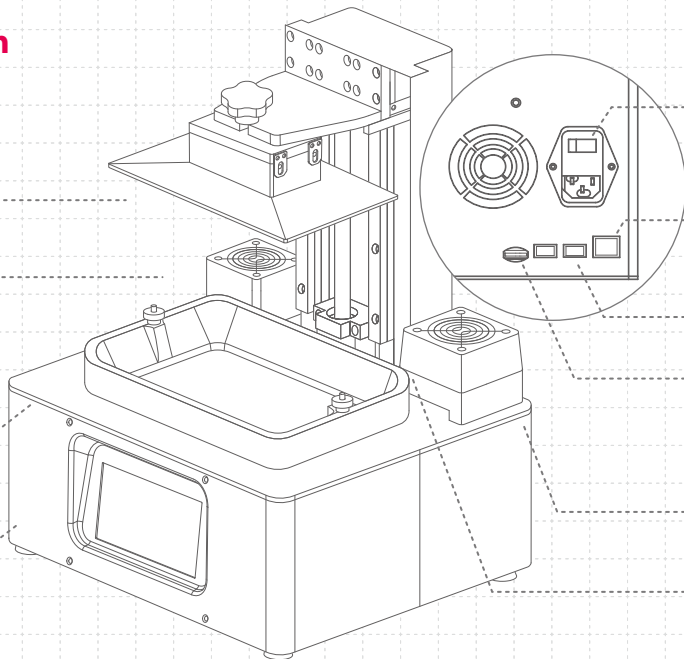

The Toolbox



After Sales Service Card



Gloves



Power Connector



Plastic Funnel



Scrapers



Allen Wrench



USB



WiFi Dongle



Handle

Operation

System	Phrozen OS
Operation	5 inch Touch Panel
Slicer Software	Phrozen Dental Synergy Slicer
Connectivity	USB Ethernet WIFI

Printing Specifications

Technology	Resin 3D Printer - LCD Type
Light Source	405nm ParaLED® 3.0 Module
XY Resolution	0.035 mm
Layer Thickness	0.01 - 0.30 mm
Max Printing Speed	90 mm / hr
Power Requirement	AC100-240V ; 50-60Hz

Hardware Specifications

Printer Size	L25 x W25 x H33 cm
Printing Volume	L13.4 x W7.5 x H20 cm
Printer Weight	14.9 kg

* All specifications have been tested in a laboratory. Please note that certain specifications may be subject to change without prior notice.

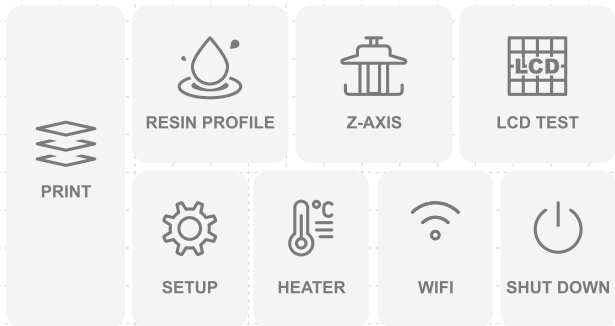

PRINT

Choose your 3D file to begin printing.

RESIN PROFILE

To adjust your settings, click on RESIN PROFILE.

Z-AXIS

Follow instructions on the manual to calibrate the Z-axis.

LCD TEST

Please follow instructions in the user manual to conduct the LCD test.

WIFI

Connects to Phrozen OS Interface.

POWER BUTTON

Click on SHUT DOWN. Then switch off the button at the back to completely turn off the device and avoid system damage.

Notice:

For first-time usage, please follow the user manual and follow the steps:
Perform Z-axis Calibration, LCD Test, and Test Printing.

If you encounter any technical problems, please contact support@phrozen3d.com

SET UP

Click on this button to REBOOT, UPDATE, EXPAND SD, adjust LIGHT settings, and view STATUS.

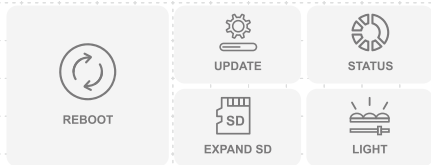

STATUS: Displays the SD Capacity, CPU temperature, and CPU Performance.

LIGHT: Manually adjust the LED light settings from 50% to 100%. The default value is set at 70%.

HEATER

Toggle the on/ off button to stabilize the printer temperature between 30 or 35°C

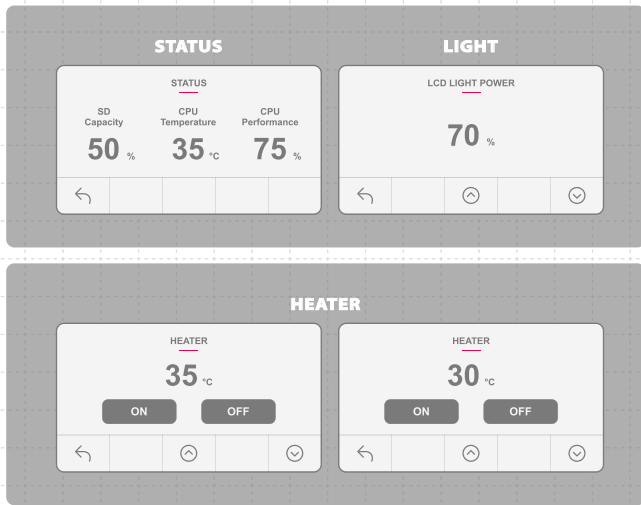

02 Key Notes Before Start

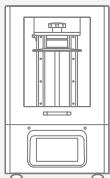

Stable Printing Environment

Store your 3D printer in a dry and ventilated environment. Avoid exposure to direct sunlight. Make sure to place it on a flat surface.

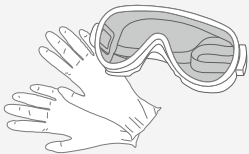

Protective Measures

While printing and using resin, please make sure to wear gloves, masks, protective goggles, and long-sleeved clothing.

Maintenance

Clean the Z-axis

First, dry clean the Z-axis T-screw. Then apply a thin layer of general lubricant on it, so that it whirls smoothly.

Clean the 3D Printer

Use sanitizing alcohol and tissue paper to carefully clean the printer, the resin vat, and the building plate.

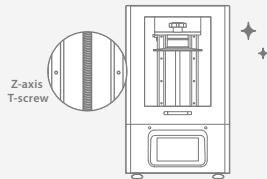

03 Z-axis Calibration

- 1 Click on Z-axis. Then click on Z-axis Calibration.
- 2 Remove the resin vat and place a piece of paper on the LCD screen.
- 3 Install the building plate and loosen all 4 screws on the building plate.
- 4 Click on NEXT.
- 5 The building plate will then be lowered to touch the LCD screen.
- 6 Tighten all 4 screws on the building plate and click DONE.
- 7 Z-axis Calibration is now complete.

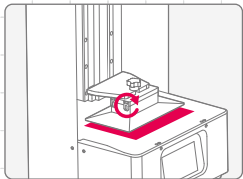
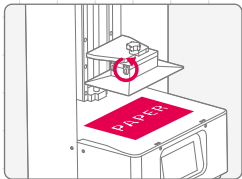

04 LCD Test

- 1 Click on LCD TEST.
- 2 There are three modes to choose from. Please test your LCD screen in the following order.
- 3 When all three modes are clearly displayed on the LCD, LCD TEST is completed.



LCD FILL UP

Confirm the LCD screen fully lights up and there are no black spots.



BLACKENED LCD SCREEN

Confirm the LCD screen covers all the light and there are no light spots.



LCD GRID

Confirm that the LCD screen displays the grid completely.

05 Set Up Resin Profiles

Setting on Printer

Using the touchscreen, follow these steps:

Resin Profiles > Choose the profile > Modify basic settings > "V"

Notice: This 3D printer will not read other settings from the slicer, except for layer height and anti-aliasing. You have to connect to Phrozen OS Interface to adjust Resin Profiles.

Connect to Phrozen OS Interface

- 1 Using the touchscreen, follow the steps:
WIFI > Choose the Wireless Network > Enter the password > Connect > OK
- 2 The WIFI network, the IP address will be shown on top of the touch panel.
- 3 Open the web browser, and type in the IP address of your resin 3D printer.

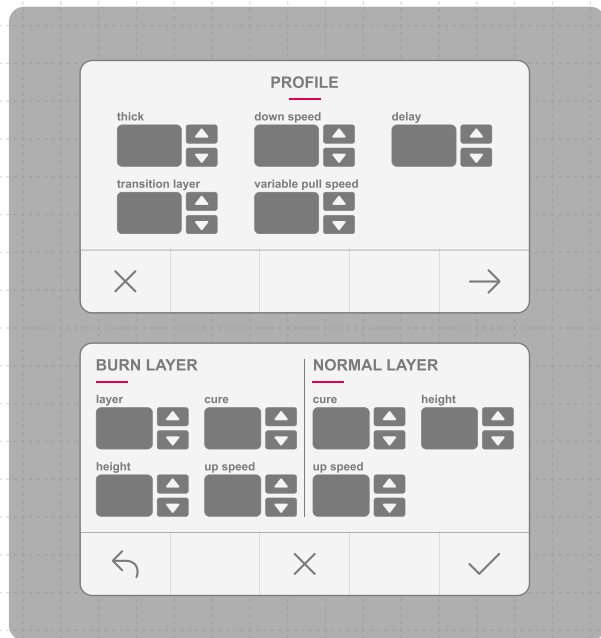

Resin Profile setting on Phrozen OS Interface

Select PROFILE page. You can adjust the resin settings, and then ADD, UPDATE, DELETE or EXPORT the resin profiles, according to your needs.



Online Resin Profile

06 Import 3D Files

via Phrozen OS Interface

- 1 Slice your 3D prints in a slicer software and save it as a **.zip file**.
- 2 Enter Phrozen OS Interface. Select PLATES page
Choose the file from your device and upload it onto the 3D printer.

via USB

- 1 Plug in the USB drive into the 3D printer.
- 2 Using the touchscreen, follow these steps:
PRINT > USB icon > 3D file.zip > Wait for Upload

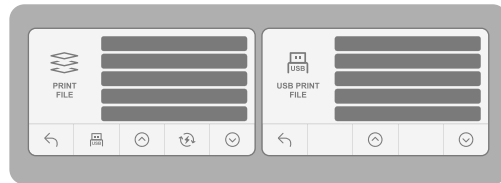

07 Perform the Printing Test

Test Printing

After adjusting the Resin Profile Settings and Importing your Files, we can now Perform the Printing Test.

- 1 Turn on the 3D printer then the Air Filtration System turn on.
- 2 Install the building plate and resin vat. Make sure that both are parallel to the printer and its surface is clean.
- 3 Shake the resin bottle for 1 minute. When pouring, make sure the resin does not exceed the mark on the resin vat.
- 4 Click on GO to begin printing. Keep the cover closed in order to prevent the 3D prints from distorting in shape.
- 5 Tilt and place the building plate onto a desk and use a metal scraper to carefully remove your print.

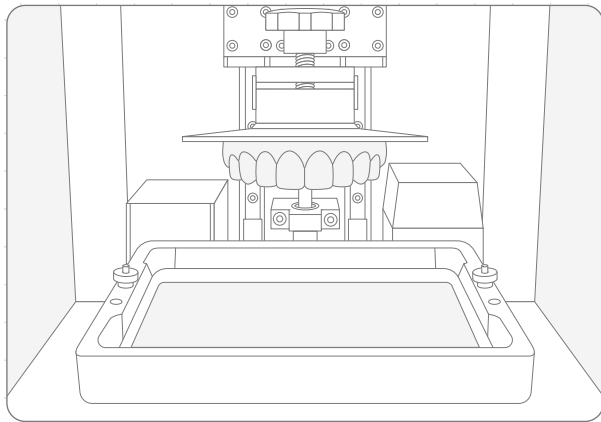

Resume Printing

During the printing process, if printing is interrupted due to power failure, or printer shutdown, the printing process will be halted. To continue printing the same 3D file, turn the power on and follow the steps below.

Click the following buttons on the touchscreen:

Print > Resume Function > Resume: Yes

Please be aware that there may be a few layer seams on the printed 3D model as a result of pausing the print.



Notice: Frequent abnormal power outages may result in system failure.

After-sales service & warranty

- Phrozen offers a one-year warranty for all parts, excluding consumable components such as the LCD screen and FEP film.
- Sonic 4K 2022 LCD screen is covered under a 3-month warranty. Please note that this warranty does not cover any damages caused by human factors.
- If you encounter any difficulties, please scan the QR codes down below to contact us.



Contact us!

Congratulations!

You have just completed your first run.
We hope you've had a great experience!

Please follow us on social media and subscribe
to our Youtube channel to learn more printing
tips, share your creations with the community.



Facebook



Facebook Group



YouTube



Official Website



Chinese User Manual



SONIC 4K
2 0 2 2

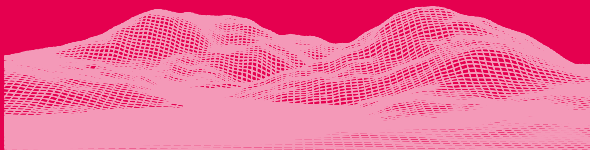

親愛的使用者您好，

非常開心您的加入，為了您良好的使用經驗，請您務必詳閱產品說明書進行產品測試及列印。若您操作上有遇到相關技術性問題，歡迎來信洽詢。

✉ 客服信箱 | support.taiwan@phrozen3d.com

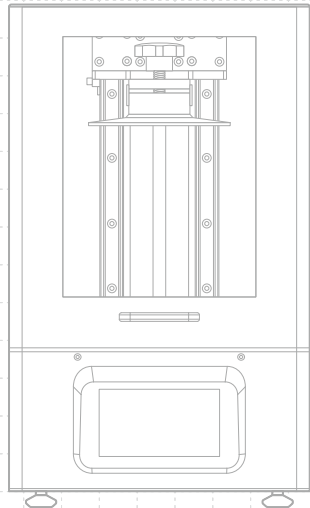

01 產品介紹

機台構造說明

PART.1

列印載台

PART.2

空氣過濾系統

PART.3

樹脂槽

PART.4

LCD 面板

PART.5

觸控螢幕

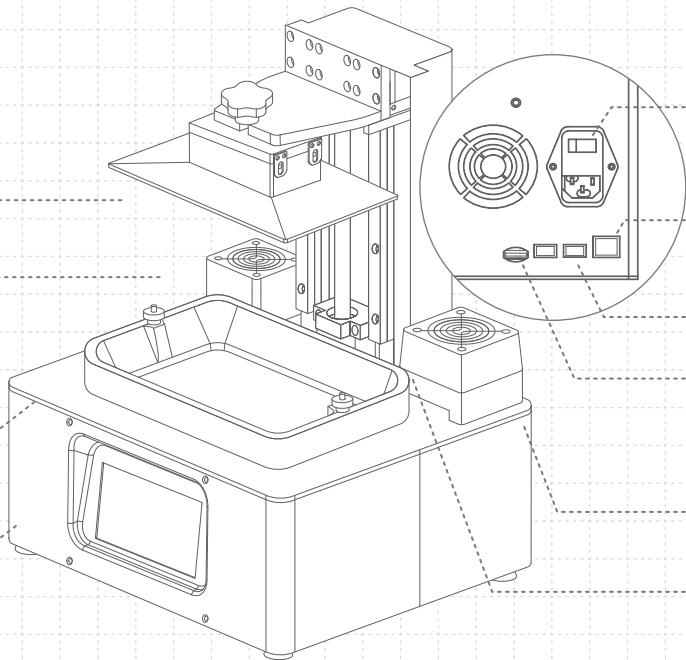

PART.8

電源開關
電源接孔

PART.9

網路接孔

PART.10

USB插孔

PART.11

Phrozen OS
SD記憶卡

PART.6

加熱器

PART.7

Z軸

配件盒內容物



客服保固卡



手套



電源線



塑膠漏斗



軟硬刮刀



六角板手



USB



USB無線網卡



把手配件

操作系統

操作系統	Phrozen OS系統
操作介面	5吋 IPS觸控面板
切片軟體	Phrozen Dental Synergy Slicer
檔案傳輸模式	USB 乙太網路 WIFI

技術規格

技術規格	光固化 3D 列印機
光源設計	405nm 波長 ParaLED Matrix 3.0
XY 解析度	0.035 mm
切層厚度	0.01-0.30 mm
最快列印速度	90 mm / 小時
適用電壓	AC100-240V ; 50-60Hz

硬體規格

機台尺寸	L25 x W25 x H33 公分
列印尺寸	L13.4 x W7.5 x H20 公分
機台重量	14.9 公斤

* 以上為實驗測試數據，若有內容更改恕不另行通知。

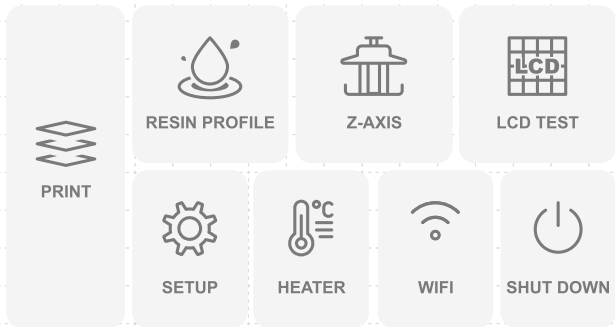

PRINT

選擇您的3D檔案並開始列印。

RESIN PROFILE

設定列印樹脂參數。

Z-AXIS

請依照說明書與觸控螢幕進行Z軸校正。

LCD TEST

請依照說明書與觸控螢幕進行LCD測試。

WIFI

使用WIFI功能連線至 Phrozen OS 操作系統。

POWER BUTTON

關閉列印機前，請先點擊SHUT DOWN再關閉列印機背面的電源開關，可以避免操作系統受損。

注意事項：

首次列印時，請依照說明書執行以下步驟：Z軸校正、LCD測試與測試列印。

若您遇到任何技術性問題，歡迎聯繫客服 support.taiwan@phrozen3d.com

SET UP

在此功能下，您可以進行重啟、更新、擴充記憶卡、調整LED光源強度與查看列印機狀態。

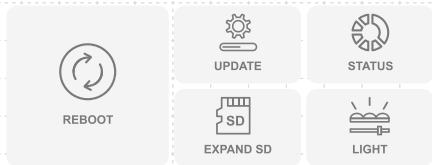

STATUS: 由左至右顯示SD記憶卡容量、CPU溫度與CPU性能。

LIGHT: 可依照使用情形，調整LED光源，光源可從50%至100%，預設的光源為70%。

HEATER

切換開關30度與35度恆溫設定。

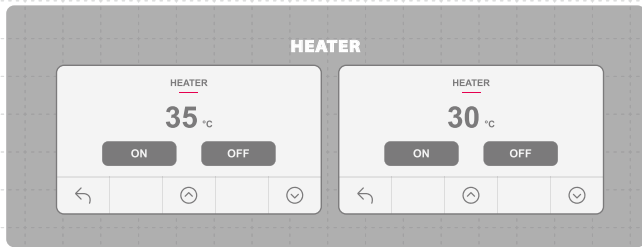
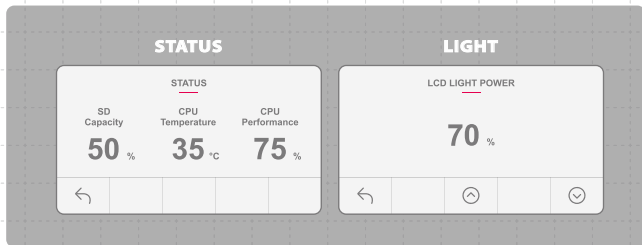

02 使用前注意事項

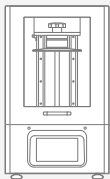

列印環境

請將3D列印機置於室內乾燥通風處之水平桌面，並避免陽光直射與高溫曝曬。

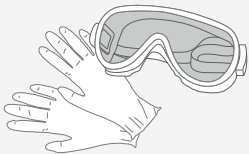

保護措施

進行列印時，請佩戴手套、口罩、護目鏡、長袖衣物等個人防護設備。

機台保養

Z軸清潔

擦乾Z軸螺桿後，請使用少量一般潤滑油，潤滑Z軸螺桿使其運行更順暢。

機台清潔

可使用消毒酒精與紙巾小心擦拭機台、樹脂槽與列印載台。

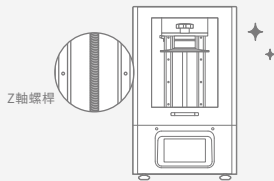

03 Z軸校正

- 1 點擊觸控面板上的 Z-axis，接著點選「O」進行Z軸校正。
- 2 移除樹脂槽並放置一張影印紙在LCD面板上。
- 3 安裝列印載台，並將兩側四顆螺絲轉鬆。
- 4 點選「NEXT」。
- 5 列印載台將會下降至接觸LCD面板。
- 6 將列印載台上4顆螺絲鎖緊後點選「DONE」。
- 7 Z軸校正完成。

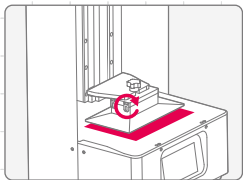
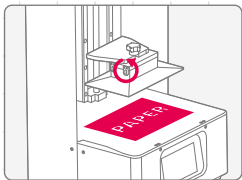

04 LCD 測試

- 1 點選「LCD TEST」。
- 2 螢幕上會出現三種模式，請依照下面順序進行測試。
- 3 當三種模式都清楚且完整呈現在LCD螢幕上，LCD測試即完成。



LCD FILL UP

請確認LCD面板全亮且無黑點。



BLACKENED LCD SCREEN

請確認LCD面板遮住所有光線且無光點。



LCD GRID

請確認LCD面板顯示完整格線。

05 設定樹脂參數

在列印機上設定

依以下步驟操作觸控面板：Resin Profiles > 選擇樹脂參數

> 調整基礎設定 > 點選「V」。

注意：此列印機只能讀取切層軟體的層高與抗鋸齒設定，連線 Phrozen OS 系統可以做細部的參數調整。

連線至Phroaen OS系統

- 1 依以下步驟操作觸控面板：WIFI > 選擇無線網路 > 輸入連線密碼 > Connect > OK
- 2 連線完成後，觸控螢幕上方將顯示列印機的IP碼。
- 3 打開網路瀏覽器，在搜尋中輸入IP碼，即可進入系統。

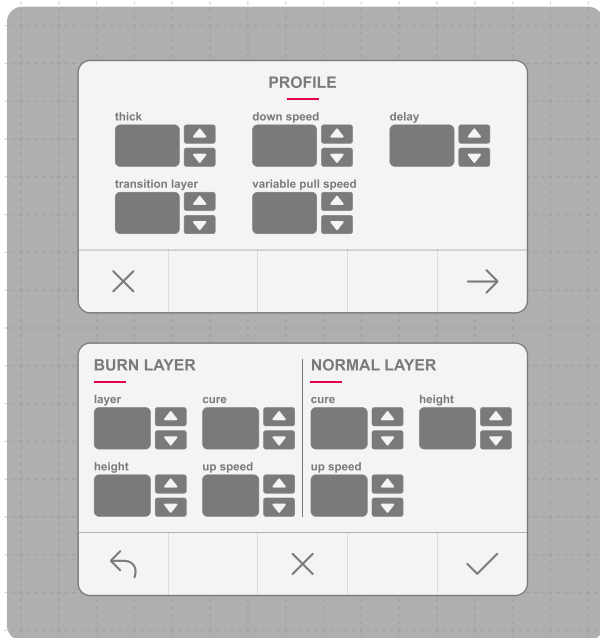

在Phroaen OS系統中設定樹脂參數

在PROFILE頁面除了調整細部的參數設定，也可利用「ADD、UPDATE、DELETE、EXPORT按鈕」執行「增加、更新、刪除、輸出設定」完成樹脂資料。



Phrozen官網樹脂參數

06 檔案傳輸

Phroaen OS系統傳輸

- 1 將3D模型透過切片軟體輸出存成 zip.檔。
- 2 進入Phroaen OS系統，進入PLATES頁面，選擇檔案上傳至列印機。

USB傳輸

- 1 將USB插入列印機。
- 2 依以下步驟操作觸控面板：PRINT > USB圖示 > 3D file.zip > 等待傳送完成。

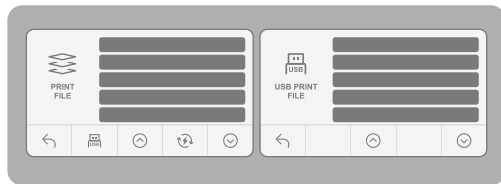

07 進行測試列印

測試列印

在設定完樹脂參數與傳送列印檔案後，即可開始進行測試
列印。

- 1 啟動3D列印機後，空氣過濾系統即會開始運轉。
- 2 安裝列印載台與樹脂槽，並確保兩者皆水平固定於機台上，且乾淨無異物。
- 3 上下搖晃樹脂1分鐘後倒入樹脂槽，倒入時請勿超出樹脂槽上「Max」標記。
- 4 點擊「GO」開始列印模型。列印中請蓋上機殼以避免其他光源影響模型成形。
- 5 列印完成後，請將列印載台斜靠桌面，使用金屬刮刀將
列印成品小心取下。

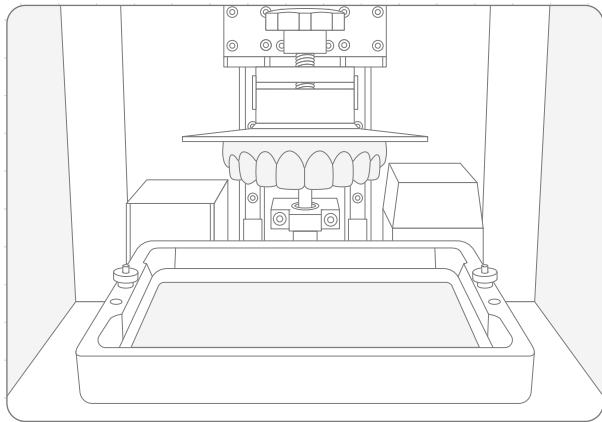

斷電續印功能

在列印過程中，如遇到斷電或列印機關機而造成列印中斷，可使用此功能繼續列印同一個模型。

欲重新列印，請重開機器，並依照以下步驟操作：

Print > Resume Function > Resume : Yes

重啟列印後的模型無可避免會產生接縫的痕跡。



注意：經常性的不正常關機會增加系統故障機會。

產品保固與售後服務

- Phrozen機台提供1年非人為損壞保固，列印耗材LCD面板與FEP膜除外。
- Sonic 4K 2022的LCD 面板提供3個月非人為損壞保固。
- 若使用上遇到任何問題，請掃描下方QRcode，聯絡Phrozen團隊。

Phrozen
客服團隊



恭喜

恭喜您完成初步操作流程，感謝您的支持並期望您有良好的使用體驗。

歡迎關注Phrozen的社群帳號，並訂閱我們的 Youtube Channel 學習更多關於列印的技巧並分享您的列印經驗。



Facebook



Facebook社團



YouTube



Phrozen官方網站